



ORGANOID
ORGANOID TECHNOLOGIES

Natural Surfaces.

	CONTENT
4 – 5	Who we are
6 – 7	What we work with
8 – 9	What we make
10 – 11	What we build on
12 – 13	Our clients
	NATURALLY INSPIRED
16 – 19	Organoid® HPL
20 – 21	Organoid® Flexi
22 – 23	Organoid® Everywhere Self-Adhesive
24 – 25	Organoid® Translucent Self-Adhesive
26 – 27	Organoid® Pure
28 – 29	Organoid® Wallpaper
30 – 31	Organoid® Acoustic
32 – 33	Organoid® Flooring
34 – 35	Organoid® 3D
35	Organoid® Roll
40 – 41	Philosophy
42 – 43	At home worldwide



Get to know the Wildspitze

The highest mountain in Tyrol towers at a majestic 3,770 m over the impressive Alpine landscape.

The Wildspitze's many ridges are home to Alpine farms and meadows, many of which are still traditionally managed today. More often than not, farmers tend to the land without the use of machines because many areas can only be reached on foot.

Considering that farmers mow by hand with pitchforks and rakes, it should come as no surprise that harvesting hay is amongst the most strenuous of activities in the Alps. Hay is gathered into special baskets worn on the back for transport into the valley.

The fragrance of hay is deeply embedded in our psyches and reminds us of a life spent working outdoors or holidays on the farm...

Bringing the fragrance of Alpine hay into your home was only achieved after years of intensive research and trials until a breakthrough in 2012: Natural materials are pressed into tiles, whereby the natural feel and colour, as well as natural fragrance are largely retained. This was a real innovation!

Our CEO Martin Jehart is a true Tyrolean native, who spends his summers high in the mountains to seek inspiration and solace after a hard day at work. Finding a name for the airy, fragrant surface made from Alpine hay was easy:

WILDSPITZE.

What makes “organoid“ unique in the world?

Interview with Martin Jehart & Christopher Egger

What does ORGANOID mean? In breaking down the ORGANOID brand, “Organic” (in the sense of natural and pristine) and “oid” (from the ancient Greek for ‘like’) are the key elements. 100% sustainability, authenticity, closeness to nature and non-treated natural materials are the ingredients of our natural surfaces.

How did the company develop? After three years of intense research and development, we founded Organoid Technologies GmbH in 2013. In the years that followed, our patented method was presented at numerous fairs and exhibitions worldwide, drawing interest from around the world in addition to numerous awards. The company currently employs 15 members of staff at its 1,200-m² facility (production and administration) in Tyrolean Oberland.

What makes ORGANOID’s natural surfaces so unique? People feel most comfortable in a natural environment. After all, humans perceive the world around them with all their senses. We are able to achieve this feeling of comfort with our ORGANOID natural surfaces. Capable of evoking strong emotions, nature in its infinite variety is now featured in interior spaces as well.

At first glance – we see the natural surfaces and recognise the raw material, e.g. lavender. Memories are evoked – grandmother’s garden, holidays in the countryside ...

Curiosity is stirred and we move our hands and fingers across a tactile surface to feel its nuances and the individual parts of plants – leaf, stem, bud & husk.

We perceive the delicate aromas with our finely tuned senses. We smell the surfaces and close our eyes: fresh Alpine hay, sweet rose, refreshing lemon, stimulating coffee ... and we pause for a moment to breathe deeply.

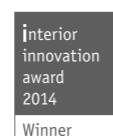



What we work with.

The fullness of nature grants us everything we need to create our natural surfaces – from A to Z – i.e. Alpine hay, hop cones, cornflower blossoms & stone-pine needles. We can utilise every natural raw material, but we prefer to use organic and regionally produced raw materials, which are not typically processed in conventional production processes. Our clients can specify natural surfaces according to colour (e.g. RAL 9004), origin (e.g. from own chocolate production) and mechanical properties (e.g. highly flexible or translucent) desired.

We are up to every challenge!

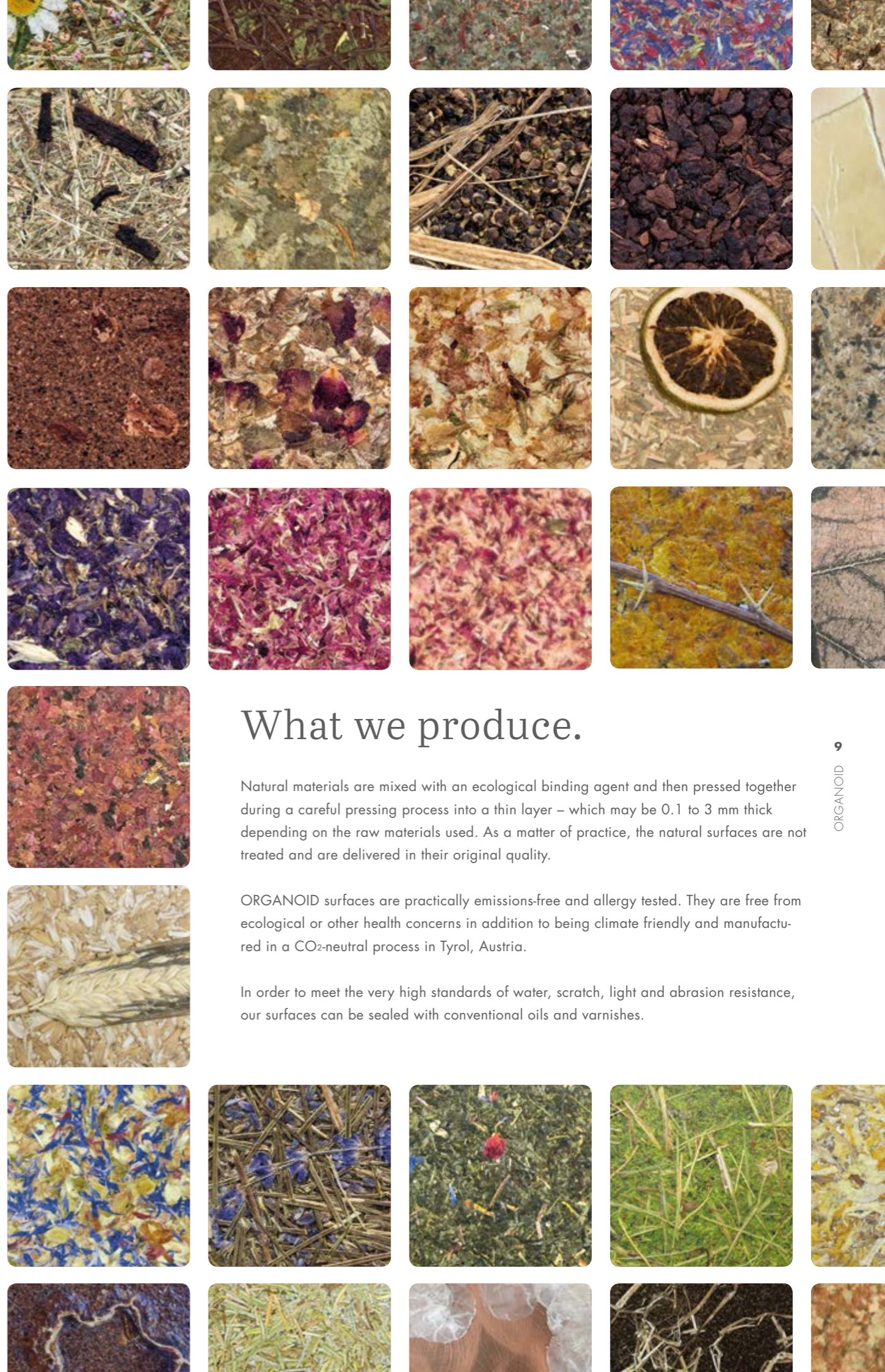

What we produce.

Natural materials are mixed with an ecological binding agent and then pressed together during a careful pressing process into a thin layer – which may be 0.1 to 3 mm thick depending on the raw materials used. As a matter of practice, the natural surfaces are not treated and are delivered in their original quality.

ORGANOID surfaces are practically emissions-free and allergy tested. They are free from ecological or other health concerns in addition to being climate friendly and manufactured in a CO₂-neutral process in Tyrol, Austria.

In order to meet the very high standards of water, scratch, light and abrasion resistance, our surfaces can be sealed with conventional oils and varnishes.

What we build on.

We press thin natural surfaces on all wooden materials, flexible liners & materials, papers and self-adhesive films. This allows us to create custom semi-finished products for every requirement.

Our product line is optimised for 3,050 x 1,320 mm. Upon request, we can also work in smaller dimensions, e.g. doors or paper sheets, or also larger dimensions, e.g. rolls up to 3 metres wide.

Nearly any natural material can be combined with our carrier materials in order to achieve the necessary specifications.

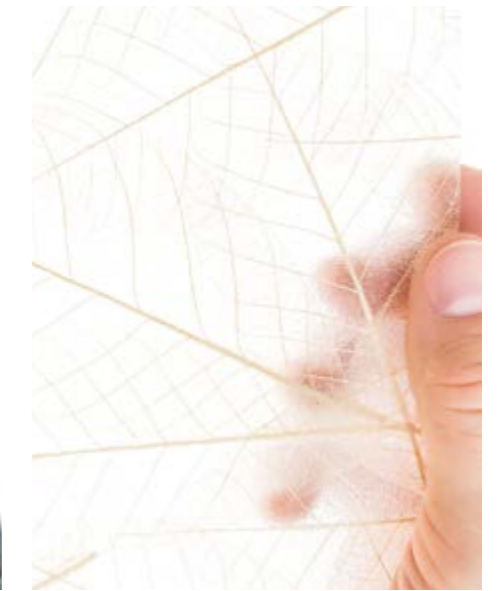

1. ORGANOID® HPL

High Pressure Laminate

0.8 – 1.2 mm according EN 438
 Dimensions: 3,050 x 1,320 mm
 Processing: like conventional laminate
 As a composite structure almost entirely flame retardant
 B s1 d0 according to EN 13501-1

2. ORGANOID® FLEXI

Thin and flexible carrier material without glue penetration

Dimensions: 3,050 x 1,320 mm
 Processing: like wood veneer
 Small bending radii : up to 0.5 mm
 Easy to cut

3. ORGANOID® EVERYWHERE SELF-ADHESIVE

Strong self-adhesive film black

Dimensions: 3,050 x 1,320 mm
 Small bending radii: possible up to 2 mm
 Easy to cut
 Easy application: peel off the protective layer from the back, stick on wherever you want, that's it.

4. ORGANOID® TRANSLUCENT SELF-ADHESIVE

Translucent self-adhesive film

Dimensions: 3,050 x 1,320 mm
 Small bending radii: up to 0.5 mm
 Easy to cut
 Easy application: peel off the protective layer from the back, stick on wherever you want, that's it.

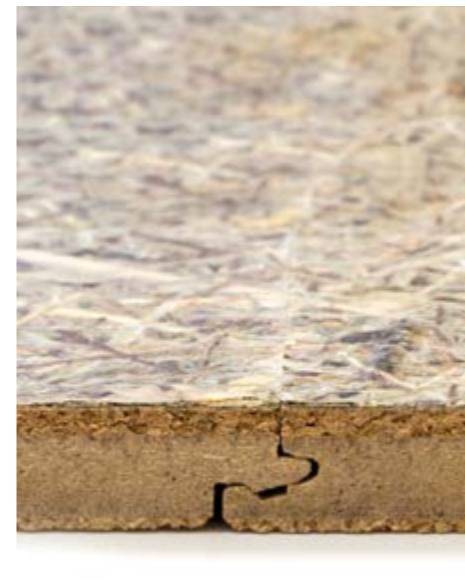
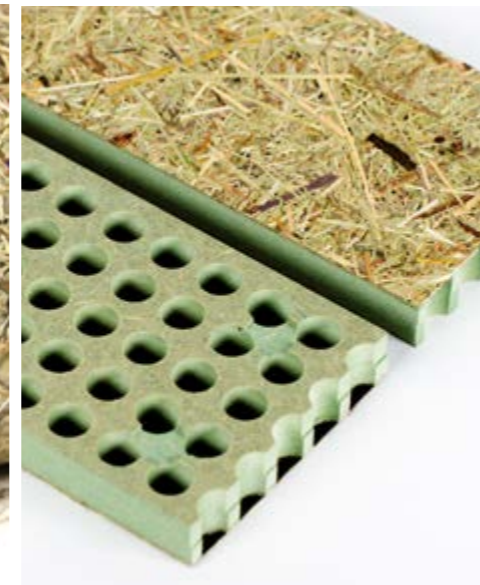

5. ORGANOID® PURE

No carrier material – pure nature

Dimensions: 3,050 x 1,320 mm
 The translucency can be defined according to customers' wishes or by the quality of fibres and the coating thickness.

6. ORGANOID® WALLPAPER

Breathable wallpaper backings or strong adhesive films for direct adhesion on plasterboard, concrete and more.

Dimensions: 3,050 x 1,320 mm
 Total thickness: approx. 1 mm
 Easy to cut

7. ORGANOID® ACOUSTICS

Acoustic non-woven fabric on perforated plywood (MDF, 3S, gypsum fibreboard).

Absorber Panels, Slot Absorbers and Picture Absorbers are proven to improve room acoustics. Various systems are available depending upon requirements.

8. ORGANOID® FLOORING

Highly concentrated, moisture-controlling natural-fibre tiles with agglomerated cork providing back tension

Easy to lay with click-system
 Classification: commercial 32
 Abrasion resistance: AC3
 Panel size: 1,230 x 305 mm

9. ORGANOID® ROLL

For use as bordering, e.g. 24 mm with oak backside or as self-adhesive sticker or wrapping film

Length on roll: min. 50 m
 Width: up to 300 mm

10. ORGANOID® 3D

Solid or coated moulded parts made from wood, aluminium, or steel. We also create surfaces for injected moulds.

Our clients.

The possibilities for combining natural and carrier materials are practically limitless, as are the various customisation options available to produce an exceptional variety of products. This allows us to serve the needs of a variety of branches. Contact us for more information!



WOOD-WORKERS, CARPENTERS

Our Organoid® HPL products are the first choice for furniture makers, carpenters, door makers and booth & shop designers. Using the existing machinery natural surfaces can be processed such as laminates. Ideal for large applications or small details, Organoid® HPL allows for the use of various materials and colour accents to emphasise the natural character of wood. To create special effects, employ Organoid® Flexi, Organoid® Roll, Organoid® Everywhere Self-Adhesive and Organoid® Flooring.



DECORATORS

Painters and wallpaper fans will love Organoid® Wallpaper, which like other heavy wallpapers, can be applied using conventional methods. Create unique and one-of-a-kind walls and ceilings in no time. Also add special effects with: Organoid® Everywhere Self-Adhesive and Organoid® PURE.



ROOM ACOUSTICS

Natural surfaces and effective sound absorption complement one another in four ORGANOID products: Acoustic non-woven fabrics, Absorber Panels, Picture Absorbers and Slot Absorbers. The acoustic panels can be hung from the ceiling and may be applied liberally to ceilings and walls or used as decorative elements for furniture, doors and walls.



3D MOULD BUILDING

Thanks to their flexibility and malleability, our natural surfaces can also be applied to 3D moulds. We deliver cover layers for plywood and compressed wood, as well as natural non-woven fabrics with Organoid surfaces for direct reshaping. Our surfaces can also be used in injection moulds. Upon request, we produce solidly constructed 3D moulded parts featuring a variety of natural materials.



DESIGNERS

Perfect for product or packaging designers and book binding specialists, the range of organoid products ensures the right natural surface for even the smallest of applications. Customers are also free to provide carrier materials, e.g. fabrics and paper. Further processing methods are possible, e.g. sewing, folding, stamping, cutting and so much more! We think you'll also be interested in: Organoid® Translucent Self-Adhesive and Organoid® PURE.



LIGHT PLANNERS

With Organoid® Translucent Self-Adhesive and Organoid® PURE, we are able to offer two products with custom definable translucencies for light planning. These products can be used, e.g. as lampshades or LED surface lighting, or as glare protection in combination with glass.



ARCHITECTS AND PLANNERS

Thanks to a low minimum order amount of just a few m² in addition to the high degree of customisation (e.g. leaves from your own garden), our products are perfect for even the smallest of projects. Naturally, we're also prepared for large projects with dimensions of several thousand square metres. We'll ensure your order is fulfilled precisely to exact specifications of surface quality ensured by consistent quality control measures employing 40 different parameters.

Naturally inspired.

Organoid® HPL

Natural surfaces on high-pressure laminates

This product group is often used to cover large walls or ceilings or as a decorative furniture element.

Conventional laminated panels are used and an array of typical machines often present in a carpentry operation are employed for processing. Organoid® HPL can already be used as a finished surface without the need for any additional processing steps. The surfaces can be protected with conventional oils and varnishes for high-demand areas requiring extra abrasion or water resistance.

TECHNICAL DATA:

- THICKNESS OF COATING:
Depending on material 0.1 – 3 mm
- CARRIER BOARD HPL:
0.8 mm to 1.1 mm according to EN 438
almost entirely flame retardant according to EN 13501
Dimensions: 3,050 x 1,320 mm (4.026 m²)
- USAGE:
without additional coating only for interior usage
- PURCHASE QUANTITY:
Prompt delivery (from just one deck) from our stock programme
Special surfaces upon request

ROASA – Sonnentor Kräuterhandels GmbH/AUT



left: RITRSCHPORN – Hotel Gmachl GmbH/AUT
bottom: KORNBLUAMA BLAU – Torsten Bauer/GER
right: WILDSPITZE – Schlosshotel Fiss GmbH/AUT



ROSCHT – Chesa Muntanella/AUT



18
ORGANOID

WILDSPITZE – Neudoerfler Office Systems GmbH/AUT



© Marcel Billaudet



19
ORGANOID

© guenterstandl.de

top: IASMIN – Hotel Gmachi GmbH/AUT
left: WOLLÄ – Grüne Erde-Store, Linz/AUT



© Grüne Erde GmbH

KAFEE on a mobile phone cover – MMore Organika Cases/SI



VINE LEAVES on hay, a special surface from the Austrian vineyard of Clemens Strobl



Organoid® Flexi

Natural coatings on a flexible carrier material

This product group makes it easy to apply a natural surface to lightweight, irregular or curved foundations. Bend radii of up to 0.5 mm are possible.

This proven veneer-reinforcing non-woven fabric or coating paper serves as a thin and flexible carrier material without bleed through. After the desired cut with scissors or cutting machine, Organoid® Flexi can be processed like wood veneer. You profit from low transport volume and weight. Organoid® Flexi is ideal wherever thin, flexible carrier materials are employed! By the way: Organoid® Flexi is perfect for sewing!

Organoid® Flexi products are available for special order. The raw materials can be selected according to colour and origin.

TECHNICAL DATA:

- THICKNESS OF COATING:
Depending on material 0.1 – 3 mm
- CARRIER:
Veneer reinforcing non-woven fabric
Dimensions: 3,050 x 1,320 mm (4.026m²)
- USAGE:
without additional coating only for interior usage
- PURCHASE QUANTITY:
On demand only,
min. 1 deck

ORGANOID® LIGHT

Printed coating paper will soon be available for reduced material applications of your choice.



ROASA – WooDone GmbH/IT

WOLLÄ – Fragrant carrying cases from Dot Design/Taiwan

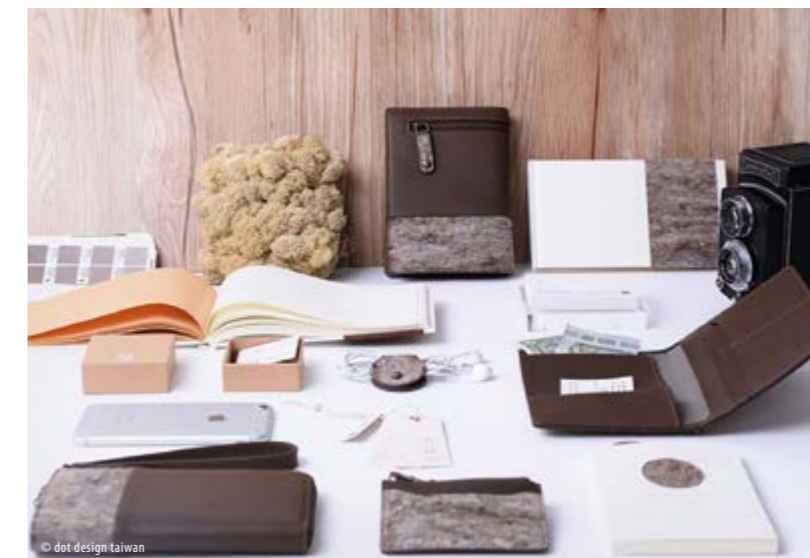

Organoid® Everywhere Self-Adhesive

Natural coatings on a strong self-adhesive film

This strong self-adhesive film is suitable for direct adhesion on plasterboard, concrete and many other materials – including raw surfaces.

After cutting, Organoid® Everywhere Self-Adhesive can be attached to nearly any surface without the need for prior experience or special tools. Simply cut with scissors or a knife and ruler to trim down to the desired dimensions. Then remove the protective layer and apply!

Organoid® Everywhere Self-Adhesive products are available for special order. The raw materials can be selected according to colour and origin.

Ideal for beautifying existing surfaces.

TECHNICAL DATA:

- THICKNESS OF COATING:
approx. 1 mm
- CARRIER:
High-quality adhesive film from the automotive industry
Dimensions: 3,050 x 1,320 mm (4.026 m²)
- EASY TO CUT
- PURCHASE QUANTITY:
on demand only,
min. 1 deck



Organoid® Translucent Self-Adhesive

Natural coatings on a translucent self-adhesive film

Our natural surfaces on a translucent self-adhesive film layer are ideal for special effects. They can be applied to smooth surfaces such as glass, metal or paper and can even be backlit!*

Organoid® Translucent Self-Adhesive products are available for special order. The raw materials can be selected according to colour and origin. The self-adhesive film allows for bend radii of up to 0.5 mm. This radius can vary depending on the raw material. Have an idea? Ask us, we would be happy to advise you. Application is easy: simply use the scissors or cutting machine to trim down to the desired size, remove the protective layer from the back side and apply. Finished! This product is light weight and profits from a small transport volume.

* We recommend testing things out in advance.

TECHNICAL DATA:

- THICKNESS OF COATING:
Depending on material 0.1 – 3 mm
- CARRIER:
translucent self-adhesive film
Dimensions: 3,050 x 1,320 mm (4.026 m²)
- USAGE:
without additional coating only for interior usage
- PURCHASE QUANTITY:
On demand only,
min. 1 deck

ROASNBLIATN – Zechner Möbeldesign, Wildon/AUT



© Harb Martina Photography

LÄRCHNNADELN – Hotel die berge, Sölden/AUT



© www.dieberge.at

SKELETTBLATTLA – Hypo Tirol Bank AG, Innsbruck/AUT



© birgitkoeff.at

Organoid® Pure

Natural coatings without carrier materials

Organoid® Pure may be applied to uneven surfaces without the need for a carrier material.

Raw materials such as Alpine hay, lavender, peppermint, and more are perfect for this product. The stalks, stems and leaves of these plants are easy to sustainably source and go great in combination with one another to create a custom natural surface.

The coating thickness corresponds to the desired translucency. Bend radii are dependent upon the raw materials used and the coating thickness.

With Organoid® Pure, you have the opportunity to select the right product for airy, light, translucent effects.

TECHNICAL DATA:

- THICKNESS OF COATING:
Depending on material 0.1 – 3 mm
- CARRIER:
No carrier material – pure nature
Dimensions: 3,050 x 1,320 mm (4.026 m²)
- USAGE:
Without additional coating only for interior usage
as a decorative element
- PURCHASE QUANTITY:
On demand only,
min. 1 deck

WILDSPITZE on Flax Backing – Leha Vorhangschienen Werner Hanisch KG/AUT



WILDSPITZE – Lichtstudio Eisenkeil/AUT



Organoid® Wallpaper

Natural surfaces on flax backing or self-adhesive film

Make your spaces sparkle with Organoid® Wallpaper.



Organoid® Wallpapers are available in two styles:

1. The flax backing of the wallpaper is breathable and can put up like any other wallpaper.
2. The strong self-adhesive film is suitable for direct adhesion on plasterboard, concrete and many other materials - such as raw surfaces.

TECHNICAL DATA:

- THICKNESS OF COATING:
approx. 1 mm
- CARRIER:
Breathable wallpaper backings or strong adhesive films for direct adhesion
Dimensions: 3,050 x 1,320 mm (4.026 m²)
- EASY TO CUT
- ADVANTAGES:
Organoid® wallpaper is free from ecological or other health concerns in addition to being climate friendly and manufactured in a CO₂-neutral process in Tyrol, Austria.
- PURCHASE QUANTITY: min. 1 deck

Raw materials can be selected for custom-made manufacture in addition to the stock collection of Organoid® Wallpapers.





PICTURE ABSORBER – Hypo Tirol Bank AG, Innsbruck/AUT



PICTURE ABSORBER – Microsoft Deutschland GmbH/GER



Organoid® Acoustics

Natural surfaces as acoustic products

During production, Organoid® Acoustic products are specially coated and transformed into finished acoustic modules with exactly defined effects.

Surfaces, acoustic adaptations, module sizes and effects can be tailored specifically for the demands of clients. Acoustic parameters, data and test reports are ascertained according to EN ISO 354. Acoustic measurements are taken according to European standards used by acoustic test institutes.

PICTURE ABSORBER, acoustic element

wood-based sheet material 16 mm, acoustic perforation, wall distance 0 mm, acoustic dumping 50 mm

Absorber class A α_w 0.90 according to EN ISO 354

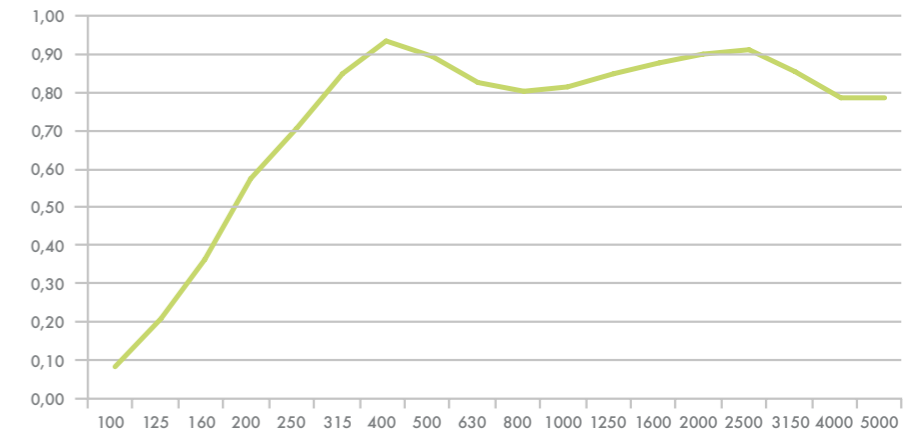

Mounting Organoid acoustic products is easy and invisible with system mounting parts.

ORGANOID® ACOUSTIC NON-WOVEN FABRIC



ORGANOID® ABSORBER PANEL



ORGANOID® PICTURE ABSORBER



ORGANOID® SLOT ABSORBER

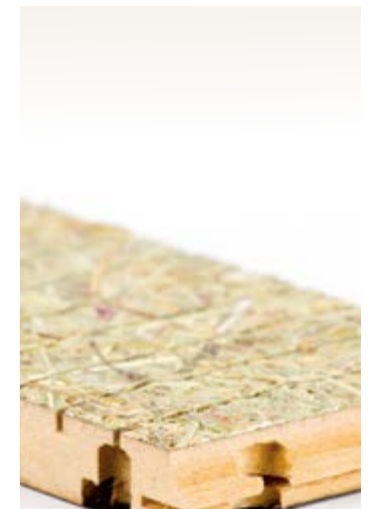

Organoid® Flooring

Natural surfaces on flooring panels

Discover the Organoid natural experience with your feet!



We developed Organoid® Flooring in cooperation with LICO AG from Switzerland. Installing this flooring is child's play thanks to a click system. Organoid® Flooring is classified object-area 32 (according to EN 16511) and is therefore ideal for high-use spaces, such as entrance areas or restaurants.

Visit www.organoids.com for more test results and classifications.

TECHNICAL DATA:

- TOTAL THICKNESS: approx. 11 mm
- DIMENSIONS: 1,235 x 305 mm
- CLASSIFICATION: Commercial 32 (EN 16511)
- TOTAL WEIGHT: approx. 8,500 g/m² (EN 430)
- IMPACT SOUND REDUCTION: approx. 17 dB (EN ISO 717-2)
- PURCHASE QUANTITY: min. 1 package (content: 5 panels, 1.88 m² total)

EASY TO LAY WITH A CLICK SYSTEM

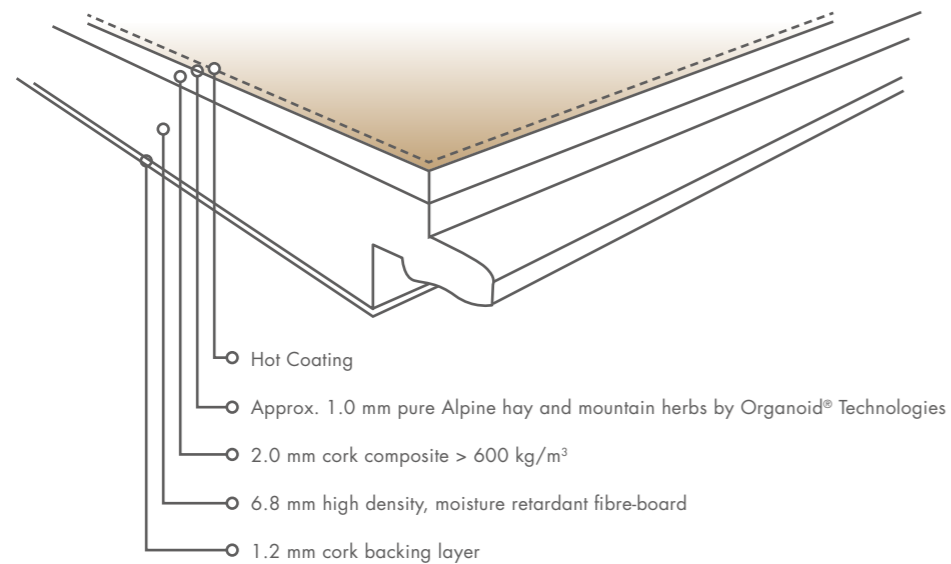

WILDSPITZE – Alpine hay





Seat shell WILDSPITZE – OWI GmbH/GER

Organoid® 3D

Natural surfaces on moulded elements

Would you like to outfit your moulded part with a different natural material? We will coat your solid or coated moulded parts made from wood, aluminium, or steel. We also create surfaces for injected moulds.

There are two different methods for creating 3D moulds:

1. Natural surfaces are set upon moulds made from foam, aluminium or steel as visible surfaces.
2. Natural raw materials are processed into solid moulded parts.

Organoid® 3D products are custom made. The raw materials can be selected according to colour and origin.

Organoid® Roll

Natural surfaces in rolls

Designed for use as a natural edgeboard for furniture or as a sticker or wrapping film, Organoid® Roll is available in your desired design variant.

TECHNICAL DATA:

- CARRIER: self-adhesive film, non-woven fabric, veneer
- WIDTH: different widths up to 300 mm
- LENGTH: as required

Hay edge band WILDSPITZE (24 mm oak backing)



Gathered from nature.

We would be happy to advise you!

Interested visitors to our showrooms or exhibition booths in Cologne, Dusseldorf, Munich, Frankfurt are themselves researchers and developers. Like visiting a test laboratory, experiment with the entire organoid product range with all your senses and: SEE. FEEL. SMELL. EXPERIENCE.



Our Philosophy.

Sustainability in every aspect

See. Feel. Smell. Experience.

Our Vision In today's increasingly technologically demanding and fast-paced world, our hope is that people will more frequently come into contact with natural materials to renew the bonds between people and the natural environment.

Our Mission Through the use of untreated natural plant parts, which have largely retained their original appearance, feel and fragrance during our production processes, we are able to bring the outdoors into interior spaces as well as the fresh smells and positive associations of nature.

Our Value System As an ambitious, young Tyrolean company, we believe in positive relations between employees, partners, suppliers and customers.

Natural Raw Materials It is our goal to make use of raw materials sourced from organic farms in addition to repurposing the by-products of food production or the agroindustry. By collaborating with farmers from the Kaunergrat Nature Park, we source the very best Alpine hay and flower petals directly from our neighbours. Whenever possible, we work with regional partners from the local community with short, environmentally responsible delivery distances.

Our Company At our facility in the Tyrolean Alps, we work with care and proven methods to ensure quality. As a climate-neutral operation, we supply our factory with 100% green power and compensate for unavoidable emissions in cooperation with our project partner ClimatePartner. Our binding agents are free of solvents, plasticizers, and all dyes and artificial fragrances.

Natural Beauty – Is at a Natural Advantage! The natural beauty of our surfaces comes from nature itself. Nature is the best designer and we do our part with technical know-how and skill so that nature is also present in interior spaces.

We're on the right track: Numerous awards and positive feedback from clients give us confidence. Join us!

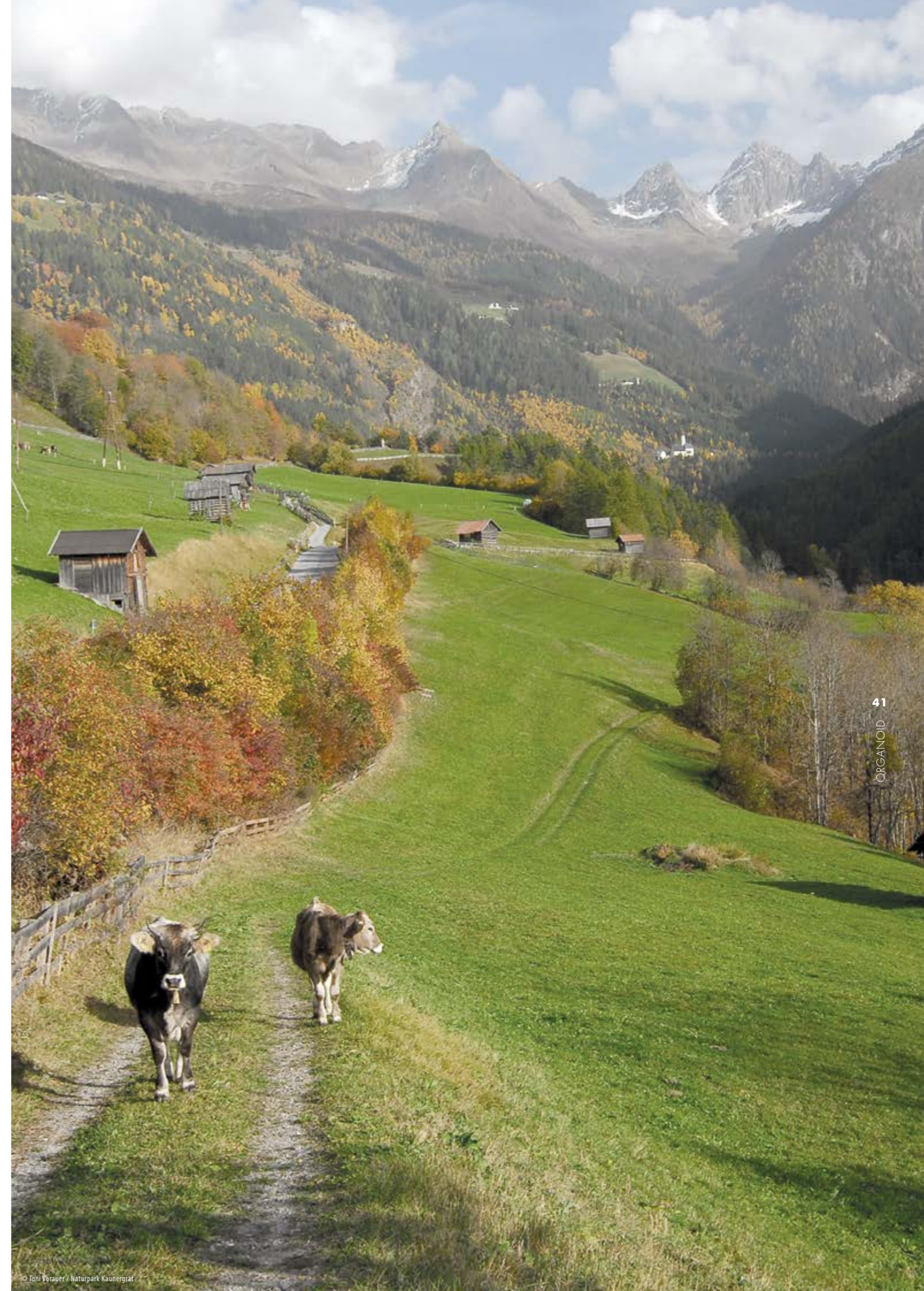

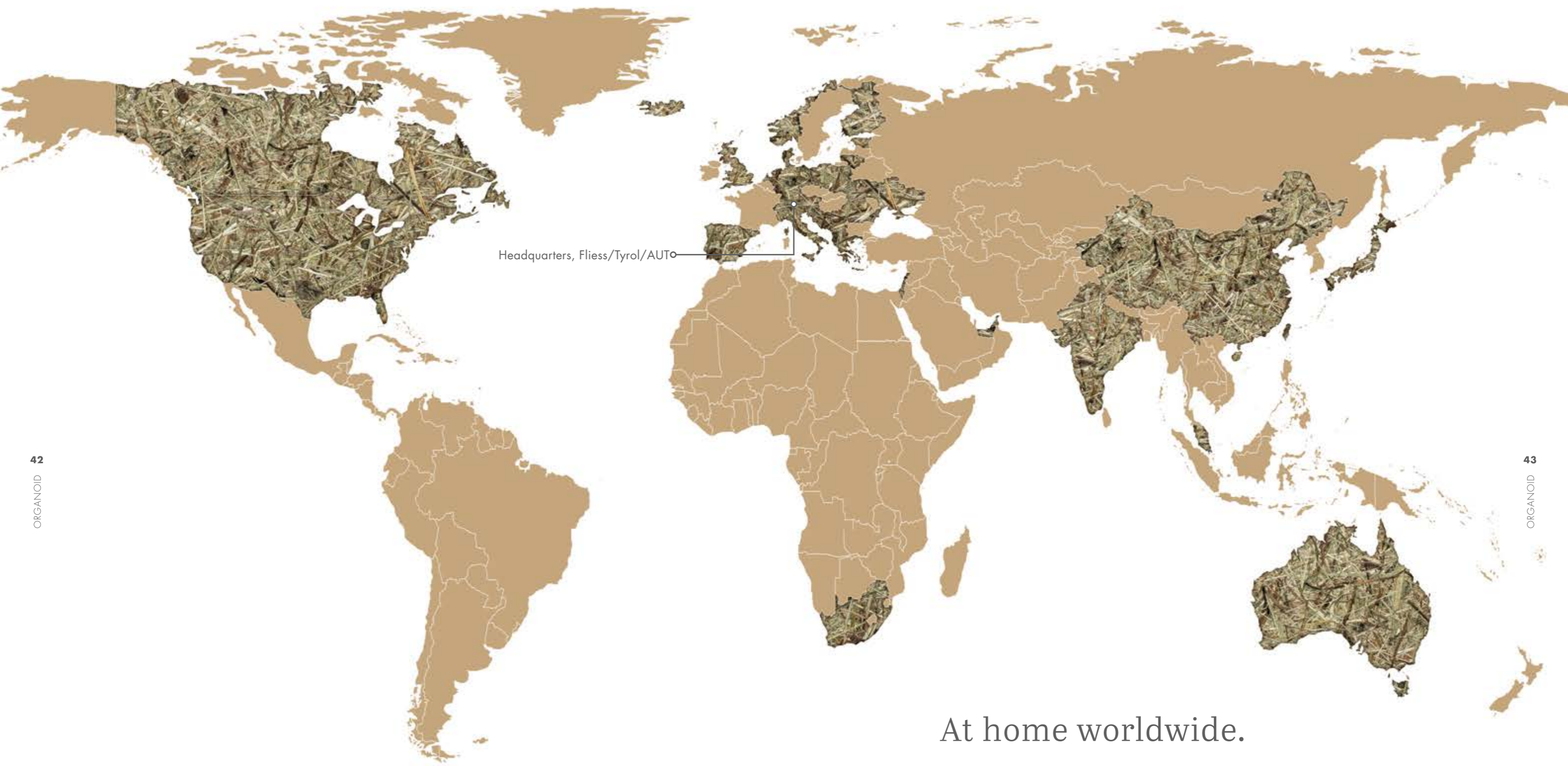

Headquarters, Fliess/Tyrol/AUTO

At home worldwide.

Our natural surfaces have made their way around the world: from Portugal to Japan and from Australia to Canada and the USA.

Our international network of sales partners and dealers is continuing to grow! We are very proud of the interest worldwide in our ORGANOID products. After all, people around the world feel most comfortable in a natural environment.



ORGANOID TECHNOLOGIES GMBH

NESSELGARTEN 422 / 6500 FLIESS / AUSTRIA
INFO@ORGANOIDS.AT / **PHONE** +43 (0) 5449 200 01 / **FAX** DW 20 / **VAT** ATU67 253 688

www.organoids.com

