

# Domino

MODULAR SOFA

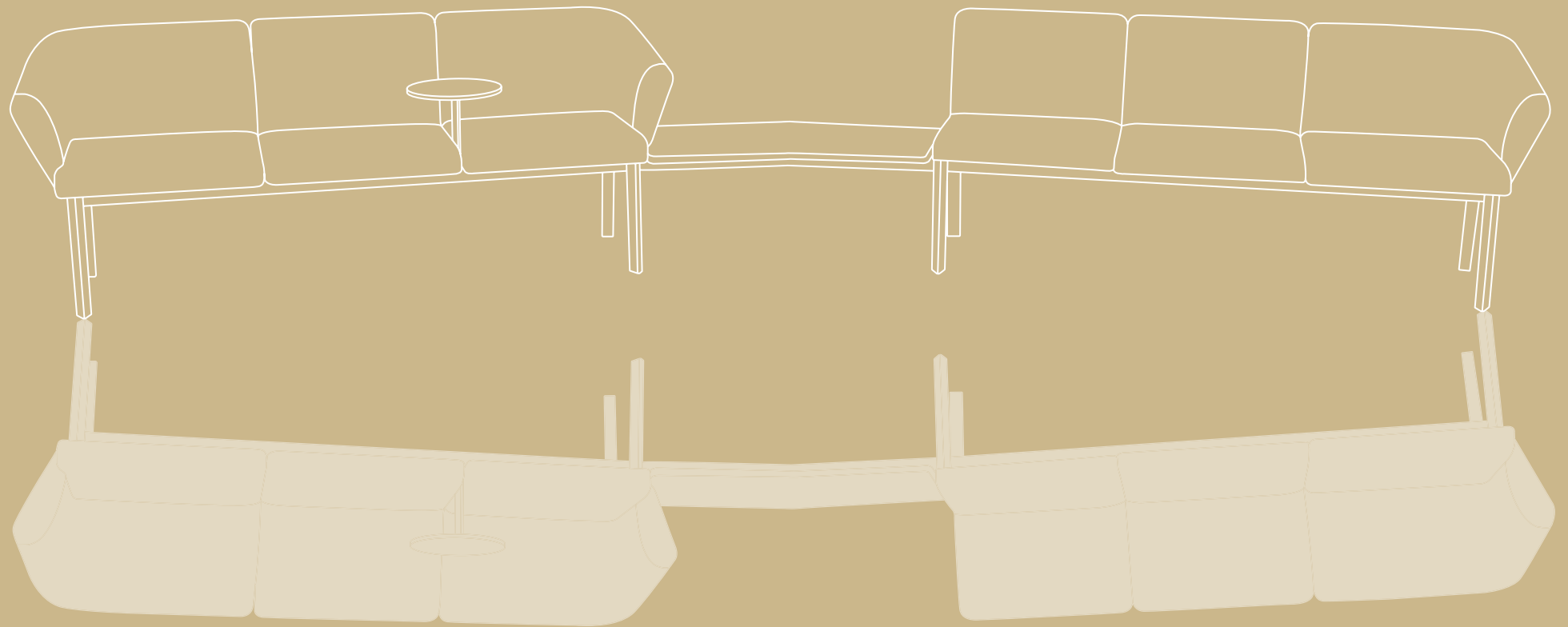



Modular sofa

# DOMINO

Domino is a cozy, modular sofa you can use in any shared space.  
Simple shapes, clean edges and comfortable dimensions.

A sofa you can admire from any angle, thanks to the many  
combinations, as a result of the modularity of its elements.



**F.lli Rossetto**  
ITALIAN COMFORTABLE SEATING

Domino Modular Sofa



**F.lli Rossetto**  
ITALIAN COMFORTABLE SEATING

## Right & Left Terminal Component

# DOMINO

To let you project your sofa at ease, we offer you a variety of components.

This component will make you complete the sofa by each side with elegance.

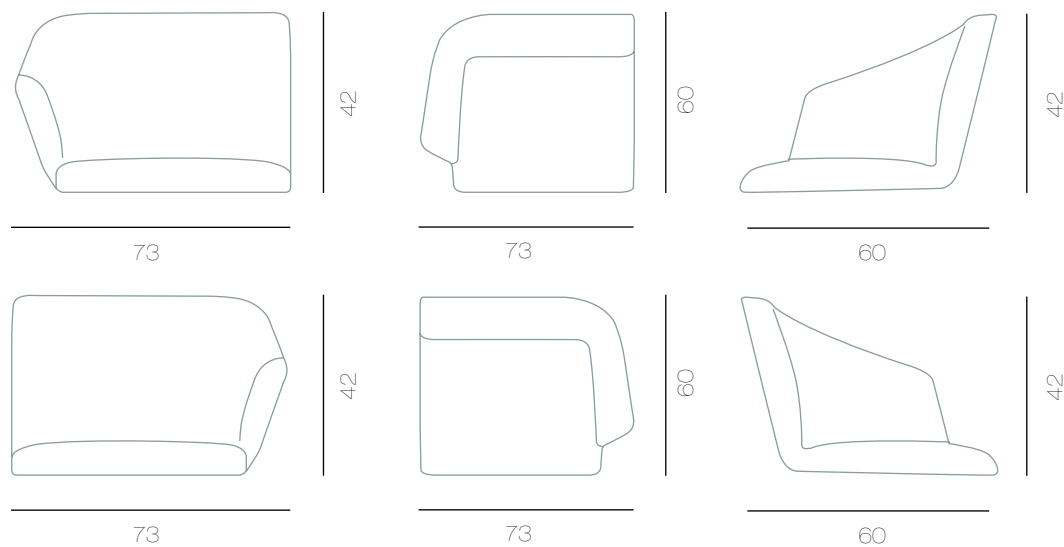

# Central element

# DOMINO

One sofa, multiple choices.

With this central element you can begin with little dimensions and join then new sections should you need them. Or, with the same ease, you can rearrange or reduce the elements as you like it.

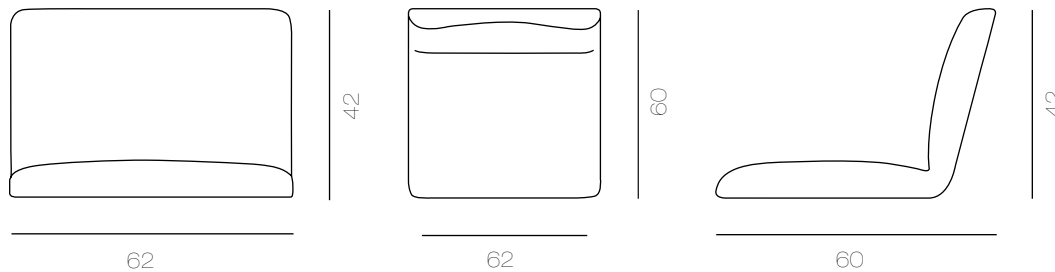

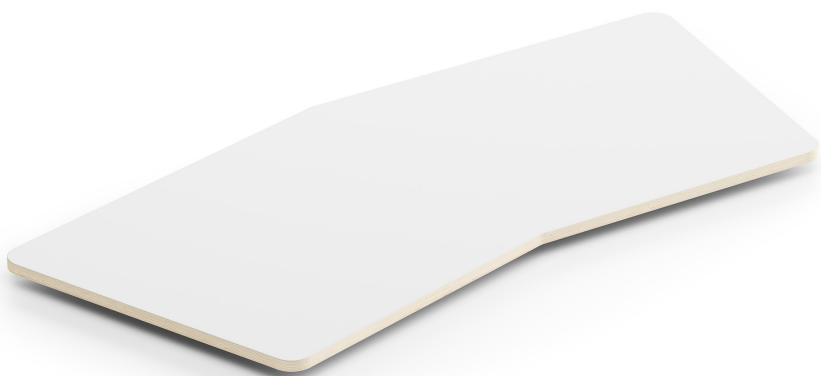

## Curved table

# DOMINO

A sturdy table in poplar plywood, certified FSC\*. Cornered edges will give you more space between the modular components. The ultimate choice to convey dynamism to your arrangements.

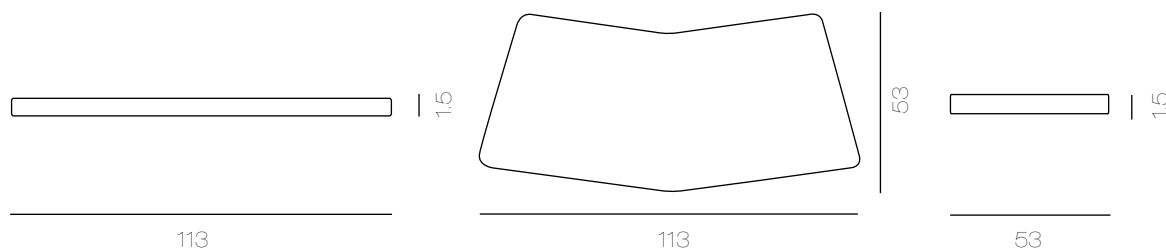

# Single table DOMINO

A practical table to keep you at hand magazines and objects. Choose the natural beauty of poplar plywood, certified FSC\*, a resistant and renewable material.

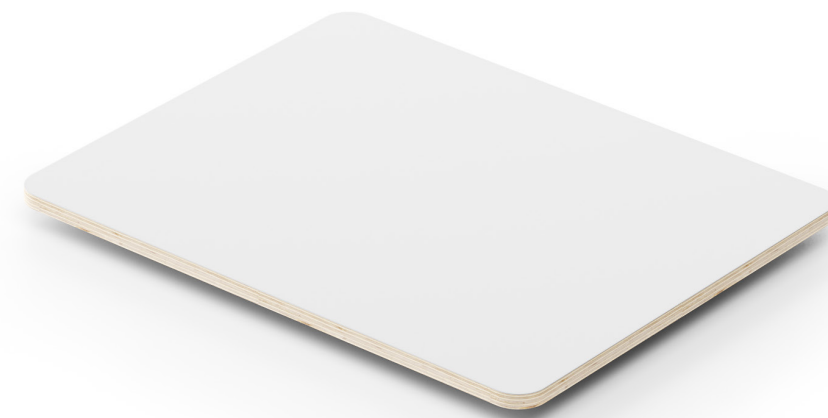
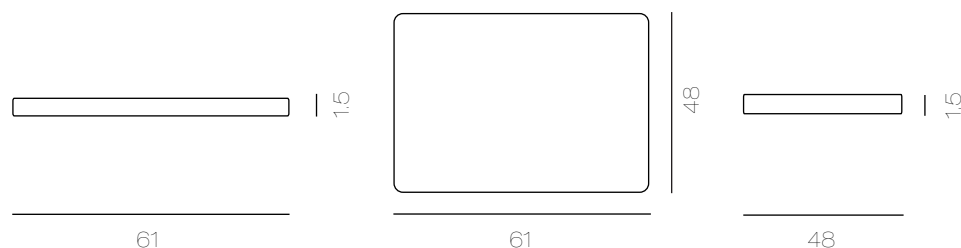





## Round table

# DOMINO

The best choice to insert between seats. Simple and linear, it lets you keep anything at hand's length, without adding too much to the composition. It is made of poplar plywood 100% FSC certified.\*

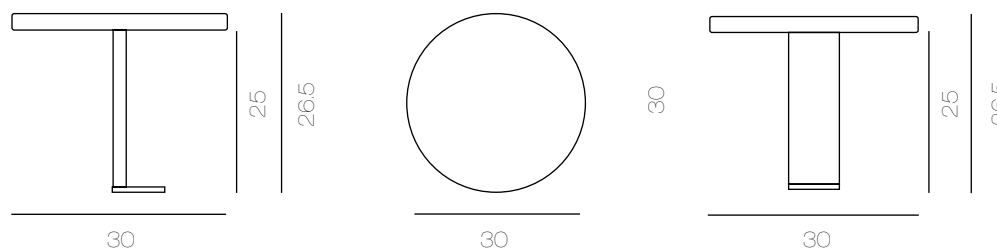

# Bases

## DOMINO

Domino lets you choose between modular two and three-seater bases. A nice two-seater is a great idea for a little space.

It lets free some space, offering a cozy space in return. If you got more space to fill in, why not choosing a three-seater or more. Let your sofa be the master piece of your place.

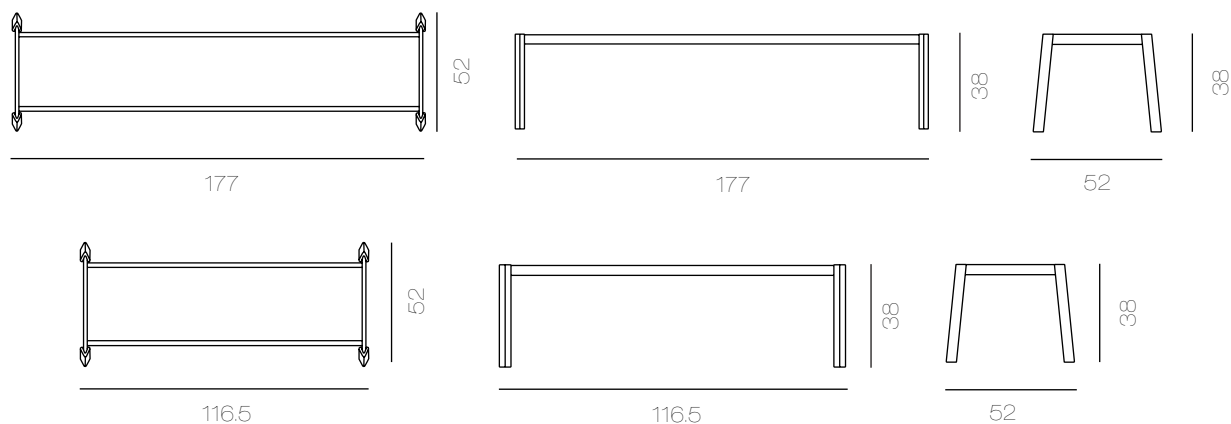



30° Angled extension  
Two-seater extension

# DOMINO

Each and every element of Domino sofa can be combined by using linear and angled brackets.

With them, creativity, dynamism and ever-new compositions will be possible.

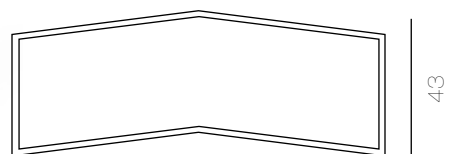

129

43

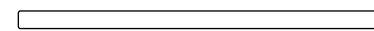

129

4.5



4.5

43

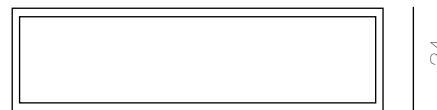

140.5

34

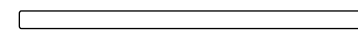

140.5

4.5

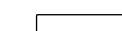

4.5

34



**F.lli Rossetto**  
ITALIAN COMFORTABLE SEATING

Domino Modular Sofa

Domino Modular Sofa



**F.lli Rossetto**  
ITALIAN COMFORTABLE SEATING



Creativity is what you search for?  
The best aspect in a modular sofa like Domino is personalization.  
Make it unique and suitable for your space,  
inspired by the composition types on our  
website.

Discover them on our website [www.rossetto.it](http://www.rossetto.it).



**F.lli Rossetto**  
ITALIAN COMFORTABLE SEATING



Creativity is what you search for?  
The best aspect in a modular sofa like Domino  
is personalization.  
Make it unique and suitable for your space,  
inspired by the composition types on our  
website.

Discover them on our website [www.rossetto.it](http://www.rossetto.it)



